

Art. E881B+M185A

Miscelatore doccia incasso

- maniglie
- deviatore a rotazione a 2 uscite
- ingressi da 1/2"
- isolamento acustico

Parte esterna

Finiture:

Acciaio spazzolato 50 93 E881B

Parte da incasso

Finiture:

44 00 M185A

Progetto:

Stanza:

Data:

Commento:

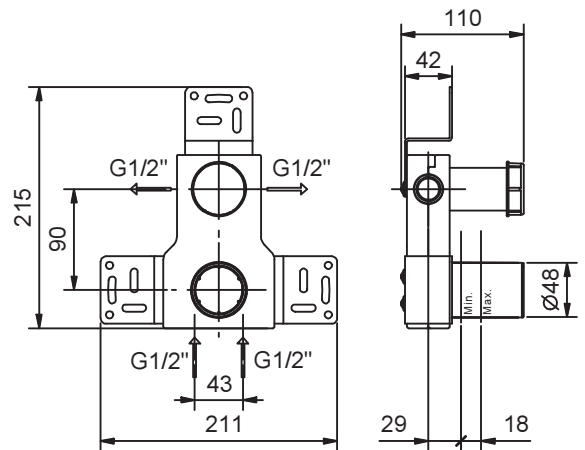
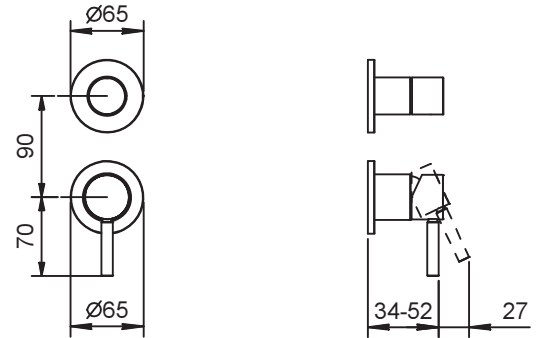

Certificazioni: