

# Tavoli Incas

## Tables, Tische, Tables, Mesas.

v. 17078 20181108/4 - TB

p. 1/6

design Angelo Mangiarotti, 1973

Tavoli in rovere per interno  
Oak tables for indoor

AINC9022072

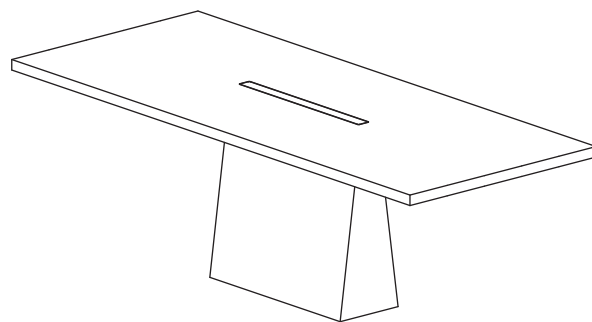

H. 72  
(28" 11/32)

AINC9022072

220 (86" 39/64)

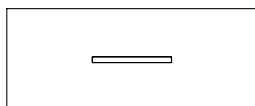
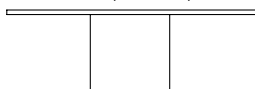

90  
(35" 7/16)

AGAPECASA

via A. Pitentino, 6  
46037 Governolo  
Roncoferraro  
Mantova - Italia

tel.+39 0376 250 311  
fax.+39 0376 250 330  
info@agapecasa.it  
agapecasa.it

# Cura e Manutenzione Maintenance and Care.

p. 2/6

Tavoli Incas  
Incas tables

design Angelo Mangiarotti, 1973

## Legno / Wood

---

Si raccomanda di utilizzare un panno umido, preferibilmente in cotone bianco e semplice sapone di Marsiglia ed asciugare. Per ridurre la manutenzione è consigliabile asciugare le superfici dopo l'uso con panno morbido, senza l'utilizzo di detergenti. Non utilizzare prodotti a base di solventi quali alcool, trielina, diluenti, acqua regia, ammoniaca ecc. e prodotti abrasivi. In caso di graffiature leggere non penetranti (viene intaccata solo la verniciatura) non viene alterata la funzionalità; per tanto resta garantita la resistenza all'acqua. Per ridurre l'inestetismo si consiglia di utilizzare prodotti cerosi e lucidare la superficie con panno morbido. In caso di ammaccature o graffiature penetranti (viene intaccata anche la parte in legno) ne viene danneggiata la funzionalità e l'acqua può penetrare tra legno e trattamento. Pertanto si deve procedere al ripristino della verniciatura tramite ritocco con utilizzo di vernici poliuretatiche trasparenti. Se il graffio o l'ammaccatura sono particolarmente profondi si rende necessaria la stuccatura. (Si consiglia di fornirsi del materiale necessario presso negozi o professionisti specializzati). È disponibile un kit di pulizia con prodotti specifici da richiedere ad Agape. Utilizzare le stesse precauzioni per le finiture laccate.

Il legno è un prodotto naturale per cui le diversità riscontrate dai campioni o tra i vari articoli non sono da ritenersi imperfezioni ma, al contrario, indice di qualità.

We recommend using a damp cloth, preferably of white cotton, and simple Marseilles soap. To reduce the need for maintenance, it is advisable to dry the surfaces with a soft detergent-free cloth after use. Do not use solvent-based products (such as alcohol, trichlorethylene, diluents, ammonia, etc.) or abrasive products. Slight surface scratches (which only damage the painted finish) do not alter the product's function, therefore, water resistance is still guaranteed. Reduce blemishes with wax-based products and polish the surfaces with a soft cloth. Dents or deep scratches (which damage the wood beneath the finish) compromise the products functional characteristics because water can penetrate between the wood and the finish. Therefore, repair the spot by touching up the finish with transparent polyurethane varnishes. If the scratch or dent is very deep, it must be filled. (We recommend purchasing the required material from specialist stores or professionals.) Agape can provide a cleaning kit with specific products upon request. Use the same precautions for lacquered finishes.

Wood is a natural product, therefore it is possible to notice differences between the samples and the various items. These differences should not be considered imperfections, but instead are signs of quality.



Tutti i prodotti Agapecasa sono progettati e realizzati per uso interno.

Non possono essere collocati all'esterno se non diversamente indicato.

All Agapecasa products are designed and manufactured for internal use.

They cannot be placed outside unless otherwise indicated.

# Istruzioni di Montaggio

## Assembly Instructions.

p. 3/6

Tavoli Incas  
Incas tables

design Angelo Mangiarotti, 1973

Contenuto della confezione  
Package Contents

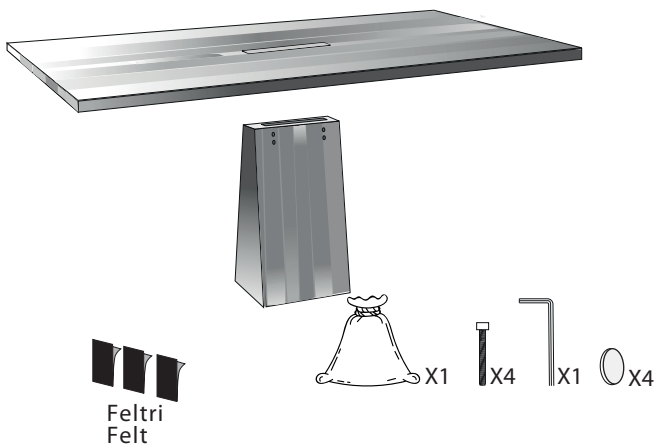

Strumenti necessari  
Required Tools

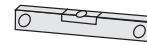

- 0.** Per applicare i feltri adesivi vedi pagina 6 e 7  
To apply the felt adhesives see page 6 and 7

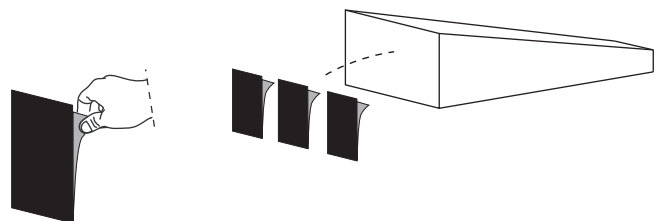

- 1.** Posizionamento dei sostegni  
Placement of the legs

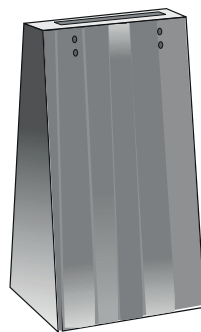

## 2.



Verificare che la ghiaia all'interno dei sacchi non sia bagnata.

Riempire i sostegni con i sacchi in dotazione.

Check that the gravel inside the bags is not wet.

Fill the supports with the supplied bags.

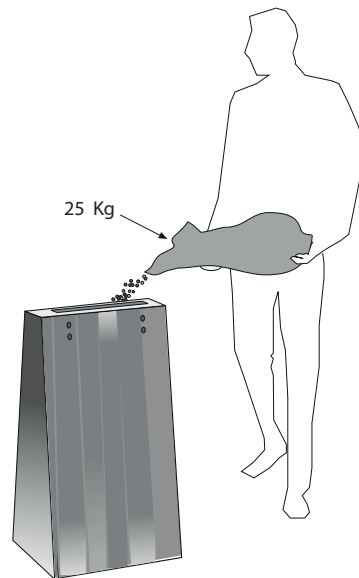

## 3.

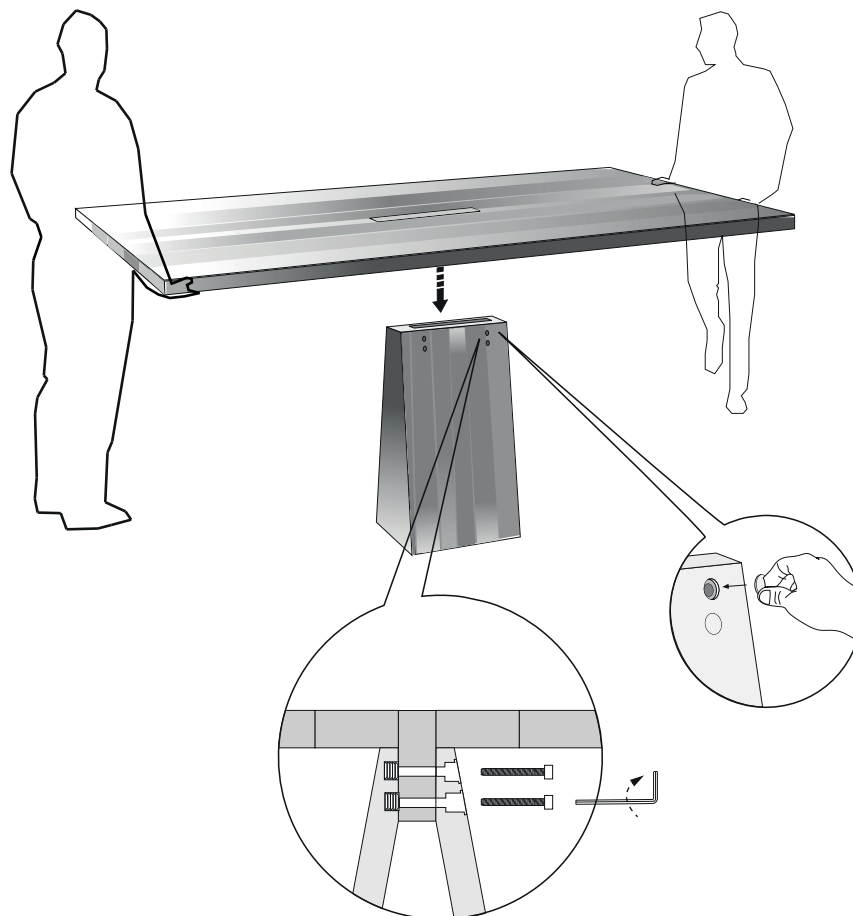

# Istruzioni di Montaggio

## Assembly Instructions.

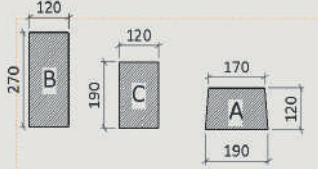
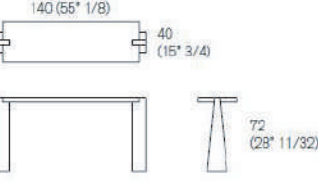
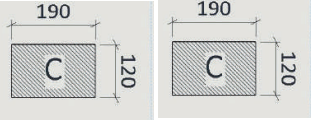
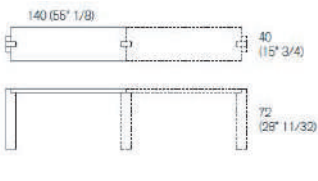
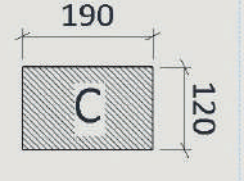
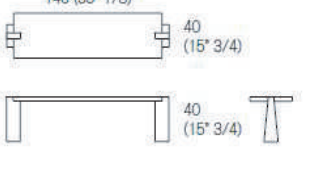
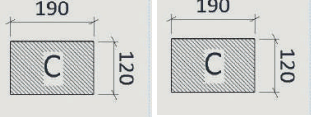
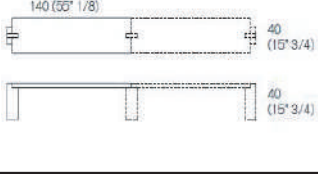
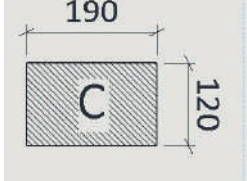
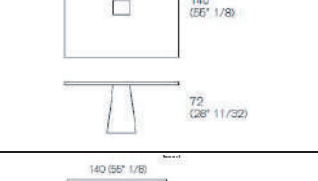
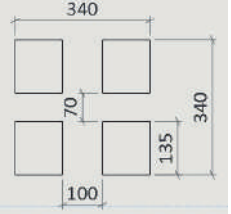
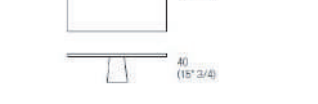
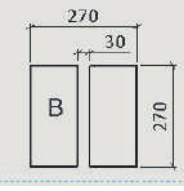
<table border="1"> <tr><td>CODICE</td></tr> <tr><td>A: PLA0739</td></tr> <tr><td>B: PLA0728</td></tr> <tr><td>C: PLA0729</td></tr> </table> 	CODICE	A: PLA0739	B: PLA0728	C: PLA0729			COD. FELTRO COD. FELT	POSIZIONE POSITION	QUANTITA' QUANTITY
CODICE									
A: PLA0739									
B: PLA0728									
C: PLA0729									
	AINC	4014072	.PLA0729		2				
	AINC	4014072M	.PLA0729		1				
	AINC	4014040	.PLA0729		2				
	AINC	4014040M	.PLA0729		1				
	AINC	14014072	.PLA0728		2 Ricavati dal tipo B				
					2				

# Istruzioni di Montaggio

## Assembly Instructions.

	AINC	9022072	.MOBINCE72	.PLA0729		5
	AINC	90240722	.MOBINCD72	.PLA0729		6
	AINC	90280722	.MOBINCD72	.PLA0729		6
	AINC	9022072	.LEGINCF72	.PLA0728		5
	AINC	90240722	.LEGING72	.PLA0728		6
	AINC	90300722	.LEGINCH72	.PLA0728		6
	AINC	90220724	.LEGINCE72	.PLA0739		4