

PENTAGRAMMA SINGLE VERTICAL

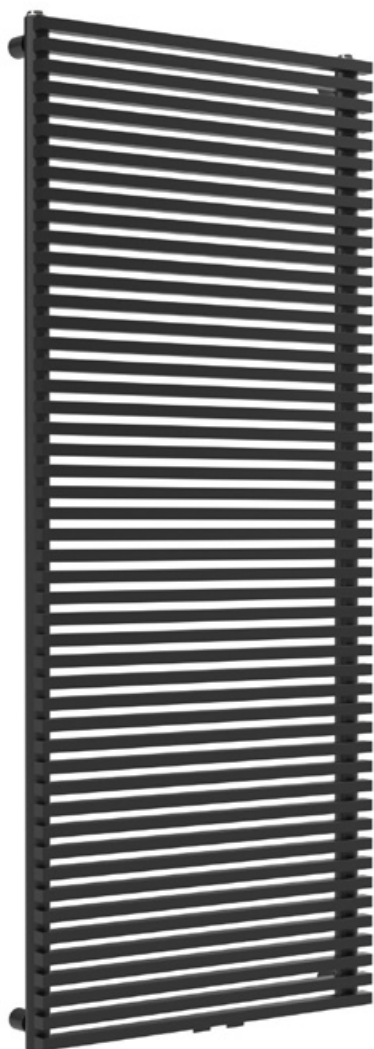

design by Gabriele e Oscar Buratti

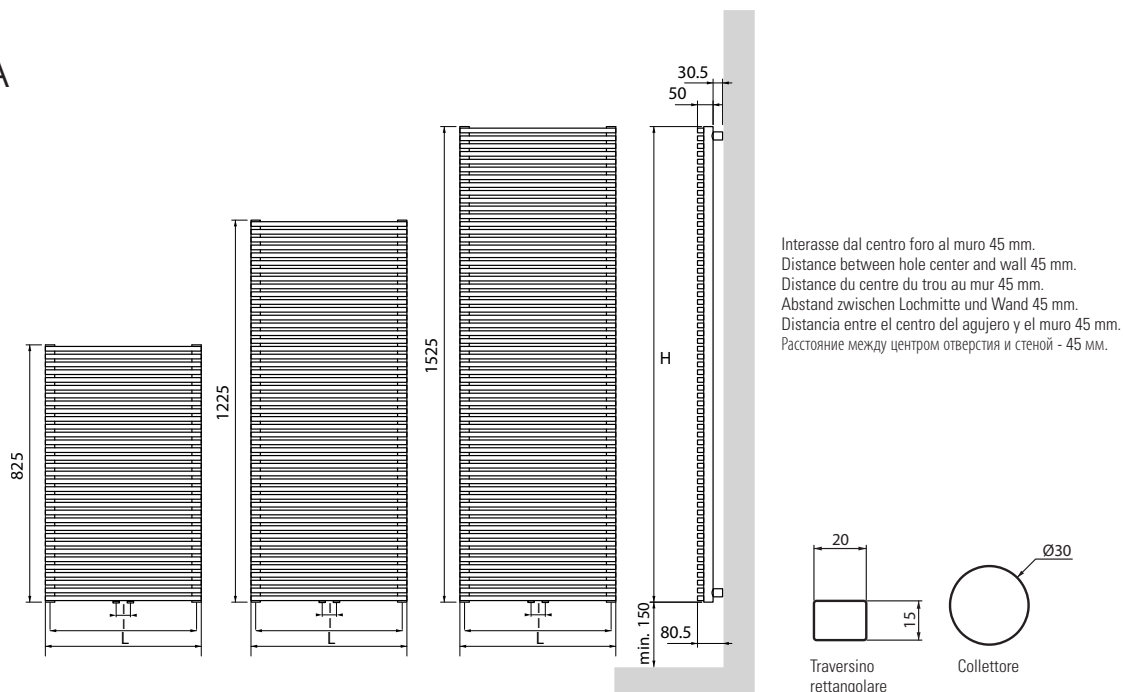

COLOURS p./s. 357

codice code code Artikel Nr. codigo код	altezza height hauteur Höhe altura высота	larghezza width largeur Breite ancha ширина	interasse distance between bars entraxe Achsabstand distancia entre centros межцентровое расстояние	peso weight pois Gewicht peso вес	Watt = Kcal/h ÷ 0,860 Kcal/h = Watt × 0,860		
					output мощность	output мощность	output мощность
					75/65-20 watt*	55/45-20 watt*	55/45-24 watt*
	H mm	L mm	I mm	Kg	Δt50	Δt30	Δt26
PEN082S040...	825	400	50 / 370	10	420	221	184
PEN082S050...	825	500	50 / 470	12	525	280	235
PEN122S040...	1225	400	50 / 370	14	630	332	277
PEN122S050...	1225	500	50 / 470	17	788	420	356
PEN152S040...	1525	400	50 / 370	17	787	414	345
PEN152S050...	1525	500	50 / 470	21	984	523	443

- * I watt hanno valori provvisori in attesa di certificazione Δt50.
- * The watt values are not definitive awaiting for Δt50 certification.
- * Le nombre de Watts est une valeur indiquée à titre provisoire dans l'attente de la certification Δt50.
- * Die Wattwerte sind vorläufig bis zur Δt50 Zertifizierung.
- * Los Vatios tienen valores provisionales en espera de la certificación Δt50.
- * До получения сертификата Δt50 приводится предварительное значение мощности в ваттах.

Massima pressione di esercizio: 8 bar
Material:
Acciaio al carbonio

Maximum working pressure: 8 bar.
Material:
Carbon-steel

Pression d'exercice maximale: 8 bars
Matériel:
Acier

Maximaler Betriebsdruck: 8 bar
Material:
Kohlenstoffstahl

Presion maxima de trabajo: 8 bar
Material:
Acero de carbon

Максимальное рабочее давление – 8 бар
Материал –
Углеродистая сталь

- ✓ Pentagramma è prodotto su licenza e non è disponibile nei seguenti paesi: Francia, Belgio e Olanda
- ✓ Pentagramma is produced under license and is not available in the following countries: France, Belgium and the Netherlands
- ✓ Pentagramma est produit sous licence et n'est pas disponible dans les pays suivants : France, Belgique et Pays-Bas
- ✓ Pentagramma wird unter Lizenz erstellt und ist in den folgenden Ländern nicht verfügbar: Frankreich, Belgien und die Niederlande
- ✓ Pentagramma está construido bajo licencia y no está disponible en los siguientes países: Francia, Bélgica y los Países Bajos
- ✓ Pentagramma производится по лицензии и недоступна для заказа в следующих странах: Франция, Бельгия и Нидерланды.

PENTAGRAMMA SINGLE VERTICAL

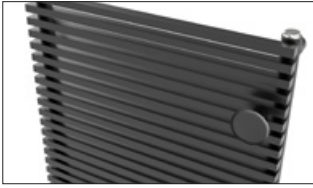

Appendiabito **a richiesta**
Towelhanger **on request**
Patère **sur demande**
Badenantelauhänger **Optional**
Colgador **bajo pedido**
Вешалка для одежды **по запросу**

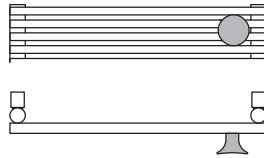

codice code code Artikel Nr. codigo код	bianco white blanc weiß blanco белый	gruppo group groupe Gruppe grupo група	gruppo group groupe Gruppe grupo група	gruppo group groupe Gruppe grupo група
	RAL 9010	A	B	C

PEN 010

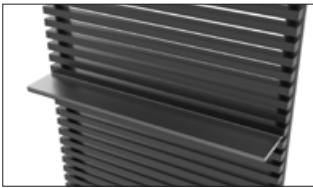

Mensola porta asciugamani **a richiesta**
Towel shelf **on request**
Étagère à serviettes **sur demande**
Handtuchablage **Optional**
Toallero **bajo pedido**
Полка для полотенец **по запросу**

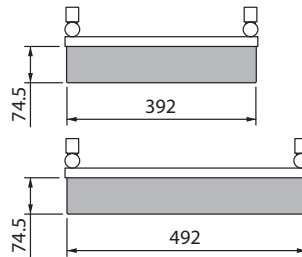

codice code code Artikel Nr. codigo код	larghezza width largeur Breite ancho ширина	bianco white blanc weiß blanco белый	gruppo group groupe Gruppe grupo група	gruppo group groupe Gruppe grupo група	gruppo group groupe Gruppe grupo група
		RAL 9010	A	B	C

PEN030 392

PEN031 492

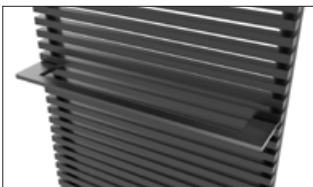

Barra portasciugamani **a richiesta**
Towel bar **on request**
Barre porte-serviettes **sur demande**
Handtuchhalter **Optional**
Portatoallas **bajo pedido**
Перекладина для полотенец **по запросу**

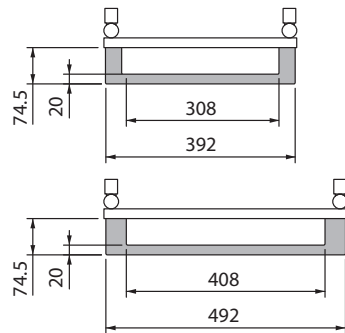

codice code code Artikel Nr. codigo код	larghezza width largeur Breite ancho ширина	bianco white blanc weiß blanco белый	gruppo group groupe Gruppe grupo група	gruppo group groupe Gruppe grupo група	gruppo group groupe Gruppe grupo група
		RAL 9010	A	B	C

PEN020 392

PEN021 492

cod. 20101934 - 20101934CR	cod. 101094 - 101094CR	cod. 10101934 - 10101934CR	cod. 101022 - 101022CR	cod. 10102034 - 10102034CR	cod. 101095 - 101095CR
p./S. 393	p./S. 400	p./S. 390	p./S. 394	p./S. 390	p./S. 401

NEW

cod. 101094C	cod. 10101934C	cod. C409C	cod. 10102034C	cod. 101095C